

High flow performance
Suitable for panel/wall mounting and manifold
Adjustment can be locked
Captive regulator needle will not blow out when unscrewed
Adjusting knob position
Releasable grab ring technology combining plastic and brass components for a compact and superior fitting design
Colour coding option with tamper-resistant feature
Red release sleeve indicating metric tube sizes
Grey release sleeve indicating inch tube sizes
Reliable and corrosion resistant

Technical data

Medium: Compressed air, filtered

Operation: Uni-directional

Mounting:

In-line. Panel mounted by hexagonal mounting nut. Wall mounted by through-holes in regulator body. Manifold by quick connection

Operating pressure:

0,1 to 10 bar maximum

Ambient temperature: -20° to +80°C

Consult our Technical Service for use below 2°C

Tube types

Nylon 11 or 12, polyurethane* and other plasticised or unplasticised tubing which conforms to the tolerances specified in DIN 73378, BS 5409/1, NFE 49-100 & 49-101, WD 16026, ISO/WD 16627

Copper and stainless steel

*Suitable for 85D, polyurethane is light-stable and has a hardness of 92 to 98 shore A.
Note: collet tube connections cannot be used for copper or stainless steel tubes, or soft plastic tubing such as 85D
Ordering information

To order quote product number from table overleaf:

eg: T15P0006 for OD6mm / OD6mm

T15Y0004 for OD1/4" / 1/4"

Alternative models

Block form flow regulators, T1000 series, see data sheet 5.9.001

Heavy duty flow regulators, M/800, M/600, see data sheet 5.9.051, 5.9.041

Precision flow regulators, M/650, M677 and S/790, see data sheet 5.9.041, 5.9.091

Materials
3, 4, 6, 8, 10 mm O/D:

Body: plastic PBT

Release sleeve, nut, knob: plastic POM

Seals: silicone free nitrile seal

External metal parts: nickel plated brass

Internal parts: brass

Spring: stainless steel

Grab ring: stainless steel, BS 1440 Pt 2, grade 301.S21

5, 12 mm O/D:

Collet: nickel plated brass

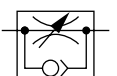



Method of assembly



1. Ensure that the end of the tube is cut square and is free from burrs.

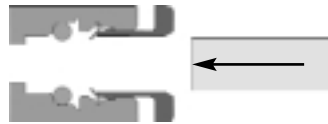

2. Push the tube through the release button and grab ring into the fitting



3. Push the tube firmly through the 'O' ring until it bottoms on the tube stop then pull back.

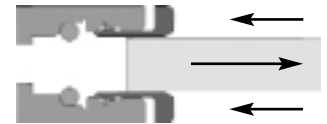

4. To disconnect, push the tube into the fitting, hold down the release button and withdraw the tube

General Information

Tube Size		Flow factor		Cracking Pressure	Minimum Operating	Weight (g)	Spare	Model	
Inch	Metric	Max. req C/CV**	Free flow C/CV**					Bar	Bar
1/8"	3 mm	0,35/0,09	>0,35/0,09	0,1	0,1	13	-	T15Y0001	T15P0003
5/32"	4 mm	0,45/0,11	>0,45/0,11	0,1	0,1	13	-	T15Y0002	T15P0004
3/16"	5 mm	0,8/0,2	0,8/0,2	0,1	0,1	32	-	T15Y0003*	T15P0005*
1/4"	6 mm	1,4/0,34	>1,4/0,34	0,1	0,1	28	-	T15Y0004	T15P0006
5/16"	8 mm	2,2/0,54	>2,2/0,54	0,1	0,1	47	-	T15Y0005	T15P0008
3/8"	10 mm	3,9/0,96	>3,9/0,96	0,1	0,1	93	-	T15Y0006	T15P0010
1/2"	12 mm	5,4/1,32	>5,4/1,32	0,1	0,1	143	-	T15Y0007*	T15P0012*

* Available only as collet tube connection

** C measured in dm³/(s.bar) Cv measured in US gal/min

Inch

	A	B	C	ØD	D ₁	K	O	P	Q max	Q min	R	S	T	V	W	X	Y	A	
T15Y0001	1/8	M10x1,0	46	2,4	4,2	13	11	13	9	35	30,5	17	11,1	6,2	0,9	13	17	1,5	3
T15Y0002	5/32	M10x1,0	46	2,4	4,2	13	11	13	9	35	30,5	17	11,1	6,2	0,9	13	17	1,5	4
T15Y0003*	3/16	M12x1,25	49	3,5	6,2	15	13,2	19	11	45,5	39	21	14,7	7,5	1,1	17	25	4	5
T15Y0004	1/4	M12x1,25	55	3,5	6,2	15	13,2	19	11	45,5	39	21	14,7	7,5	1,1	17	25	4	6
T15Y0005	5/16	M14x1,5	65,5	3,5	6,2	18	14,8	21	15,5	52	44	23,5	14,7	8,1	1,3	21,5	27	4	8
T15Y0006	3/8	M20x1,5	76,8	4,4	7,9	24	17,8	26,5	19	61,5	53	29	18,9	10	1,6	26,5	34	5	10
T15Y0007*	1/2	M20x1,5	92,5	4,4	7,9	24	22,2	28,5	22,5	66	55,5	32	22,2	12,1	1,6	30	36	5	12

* Available only with collet tube connection

Metric

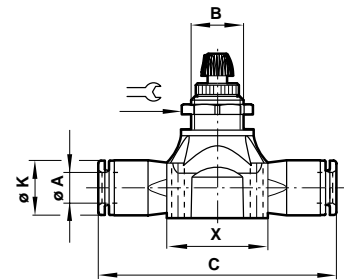

Flow vs turns at 6 bar - flow in dm³/s ANR

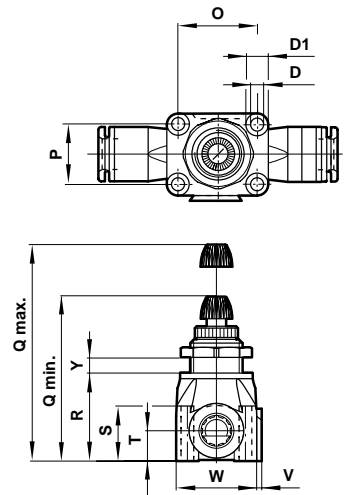
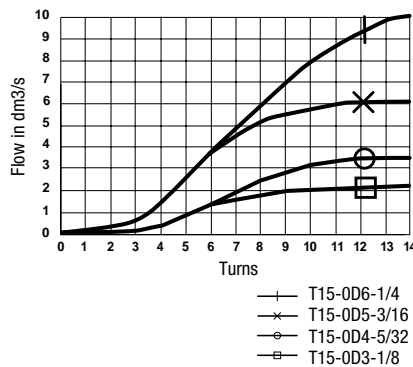
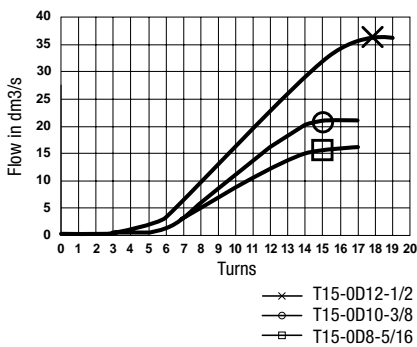

Warning

These products are intended for use in industrial compressed air systems only. Do not use these products where pressures and temperatures can exceed those listed under 'Technical Data'.

Before using these products with fluids other than those specified, for non-industrial applications, life-support systems, or other applications not within published specifications, consult NORGREN.

Through misuse, age, or malfunction, components used in fluid power systems can fail in various modes. The system designer is warned to consider the failure modes of all component parts used in fluid power systems and to provide adequate safeguards to prevent personal injury or damage to equipment in the event of such failure.

System designers must provide a warning to end users in the system instructional manual if protection against a failure mode cannot be adequately provided.

System designers and end users are cautioned to review specific warnings found in instruction sheets packed and shipped with these products.