

Sub-base mounted 2x3/2, 5/2 and 5/3 Valves
Solenoid actuated with Wireway
G1/8, Ø 4mm or Ø 6mm

- Multipole design for easy installation
- IP40, IP65 and NEMA 4 Conduit entry models
- Fieldbus compatible
- Dedicated AS-Interface modules
- 24 Vdc or 24 Vac options
- G1/4 Ø 4 mm or Ø 6 mm PIF ports
- Common positive available as an option



Technical data Valves

Medium:

Compressed air, filtered to 40 µm, lubricated or non-lubricated

Operation:

Spool valve, indirectly actuated

Port size (sub-base):

G1/8, Ø 6mm Ø 4mm

Operating pressure:

2 to 8 bar

Temperature range:

-20°C to +50°C

*Consult our Technical Service for use below +2°C

Materials

Aluminium alloy body, glass filled co-polymer end caps, aluminium spool with HNBR seals.

Flow characteristics: Port size: G1/8

	A'	'C'	'b'	l/min	SCFM	Cv	Kv
2 x 3/2 NC	4,07	1,02	-	265	3,60	0,25	0,21
2 x 3/2 NO	4,64	1,14	-	356	4,53	0,28	0,24
5/2	5,46	1,37	0,51	406	5,06	0,33	0,28
5/3 COE	3,60	0,89	-	250	3,33	0,22	0,19
5/3 APB	2,72	0,68	0,20	204	2,70	0,16	0,14
5/3 COP	3,37	0,84	-	232	2,90	0,20	0,17

Technical data Wireway

Indication by yellow LED

Suppression by flywheel diode

Degree of protection:

IP40 'D' sub-connector

IP65 'D' sub-connector with seal

IP65 and NEMA 4 conduit entry type

IP65 Round "Bayonetlock" connector

Ordering information

To order, complete Valve Specification Form on page 5.4.113.06 and fax to your local IMI Norgren office for free consultation service.



General information
2x3/2 Double solenoid actuated valves

Symbol	Model	Manual* Override	Function 2x3/2	Solenoid Pilot supply	Actuation	Operating Pressure (bar)	Solenoid pilot Pressure (bar)	Weight (kg)	Order Code
	V206A11A-B213R	sdmo	Normally closed	Internal	Sol/spring	2,2 to 8	-	135	01
	V206A11A-B313R	pbmo							02
	V206B11A-B213R	sdmo	Normally open	Internal	Sol/Spring	2,2 to 8	-	135	03
	V206B11A-B313R	pbmo							04
	V206A22A-B213R	sdmo	Normally closed	External	Sol/Spring	-0.9 to 10	2,2 to 8	135	05
	V206A22A-B313R	pbmo							06
	V206B22A-B213R	sdmo	Normally open	External	Sol/Spring	-0.9 to 10	2,2 to 8	135	07
	V206B22A-B313R	pbmo							08
	V206C11A-B213R	sdmo	Normally open/ normally closed	Internal	Sol/Spring	2,2 to 8	-	135	09
	V206C11A-B313R	pbmo							10
	V206C22A-B213R	sdmo	Normally open/ normally closed	External	Sol/Spring	-0.9 to 10	2,2 to 8	135	11
	V206C22A-B313R	pbmo							12

5/2 Solenoid/spring actuated valves

Symbol	Model	Manual* Override	Solenoid pilot supply	Mid position	Operating pressure (bar)	Solenoid pilot pressure (bar)	Weight (kg)	Order Code
	V206517A-B213R	sdmo	Internal	Sol/Spring	1,8 to 8	-	110	13
	V206517A-B313R	pbmo						14
	V206527A-B213R	sdmo	External	Sol/Spring	-0,9 to 10	1,8 to 8	110	15
	V206527A-B313R	pbmo						16
	V206513A-B213R	sdmo	Internal	Sol/Air	1,5 to 8	-	110	17
	V206513A-B313R	pbmo						18
	V206523A-B213R	sdmo	External	Sol/Air	-0,9 to 10	1,5 to 8	110	19
	V206523A-B313R	pbmo						20
	V206511A-B213R	sdmo	Internal	Sol/Sol	1,2 to 8	-	125	21
	V206511A-B313R	pbmo						22
	V206522A-B213R	sdmo	External	Sol/Sol	-0,9 to 10	1,2 to 8	125	23
	V206522A-B313R	pbmo						24

5/3 Double solenoid actuated valves

Symbol	Model	Manual* Override	Solenoid pilot supply	Mid position	Operating pressure (bar)	Solenoid pilot pressure (bar)	Weight (kg)	Order Code
	V206611A-B213R	sdmo	Internal	APB	2,2 to 8	-	135	25
	V206611A-B313R	pbmo						26
	V206622A-B213R	sdmo	External	APB	-0,9 to 10	2,2 to 8	135	27
	V206622A-B313R	pbmo						28
	V206711A-B213R	sdmo	Internal	COE	2,2 to 8	-	135	29
	V206711A-B313R	pbmo						30
	V206722A-B213R	sdmo	External	COE	-0,9 to 10	2,2 to 8	135	31
	V206722A-B313R	pbmo						32
	V206811A-B213R	sdmo	Internal	COP	2,2 to 8	-	135	33
	V206811A-B313R	pbmo						34
	V206822A-B213R	sdmo	External	COP	-0,9 to 10	2,2 to 8	135	35
	V206822A-B313R	pbmo						36

APB = All Ports Blocked
COP = Centre Open Pressure
pbmo = push button mono-stable

COE = Centre Open Exhaust
sdmo = screwdriver bi-stable

Note:
Customers are advised that to comply with the Machinery Directive Manual override type PBMO should be selected

* Valve without manual override can be supplied to special order. Change 11th digit to 1 i.e. V20-----1---



Electrical details

Wireway

Voltage:	24V d.c. 1,5W	24V a.c
Surge suppression:	Flywheel diode	Flywheel diode
Indication:	Yellow LED	Yellow LED

Solenoids

Voltage tolerance:	±10%
Rating:	100%ED

Accessories (Order codes in bold)

D Sub-connector IP40	D Sub-connector IP65 with seal	Blanking plate	Intermediate supply/Exhaust plate	Pressure switch
V10020-E01 1 metre A1	V11063-E01 1 metre A4	V095516A-Q1100 A7	V095516A-Q160G A8	V095516A-Q1700 A9
V10020-E03 3 metre A2	V11063-E03 3 metre A5			
V10020-E05 5 metre A3	V11063-E05 5 metre A6			
DIN Rail mounting kits	DIN Rail fixing kit	Blanking disk set	Remote output module	Port 1 pressure regulator
V10009-C00 1 metre A10	V10920-K01 A11	V095516A-Q1900 A18	VE1MP20B-00400	V11270-K02 A22

V20 Models

2x3/2 and 5/2 Double solenoid actuated valves

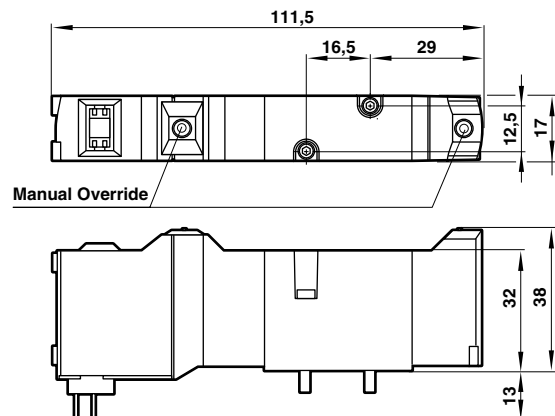

5/3 Double solenoid actuated valves

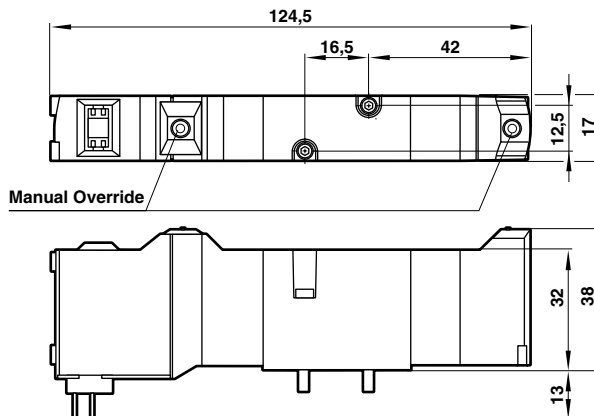

5/2 Solenoid/Spring actuated valves

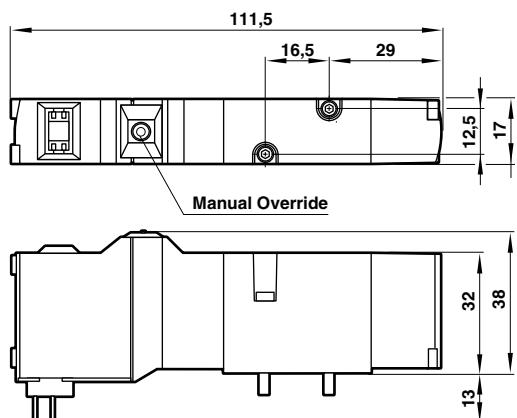



Modular sub-base assembly dimensions

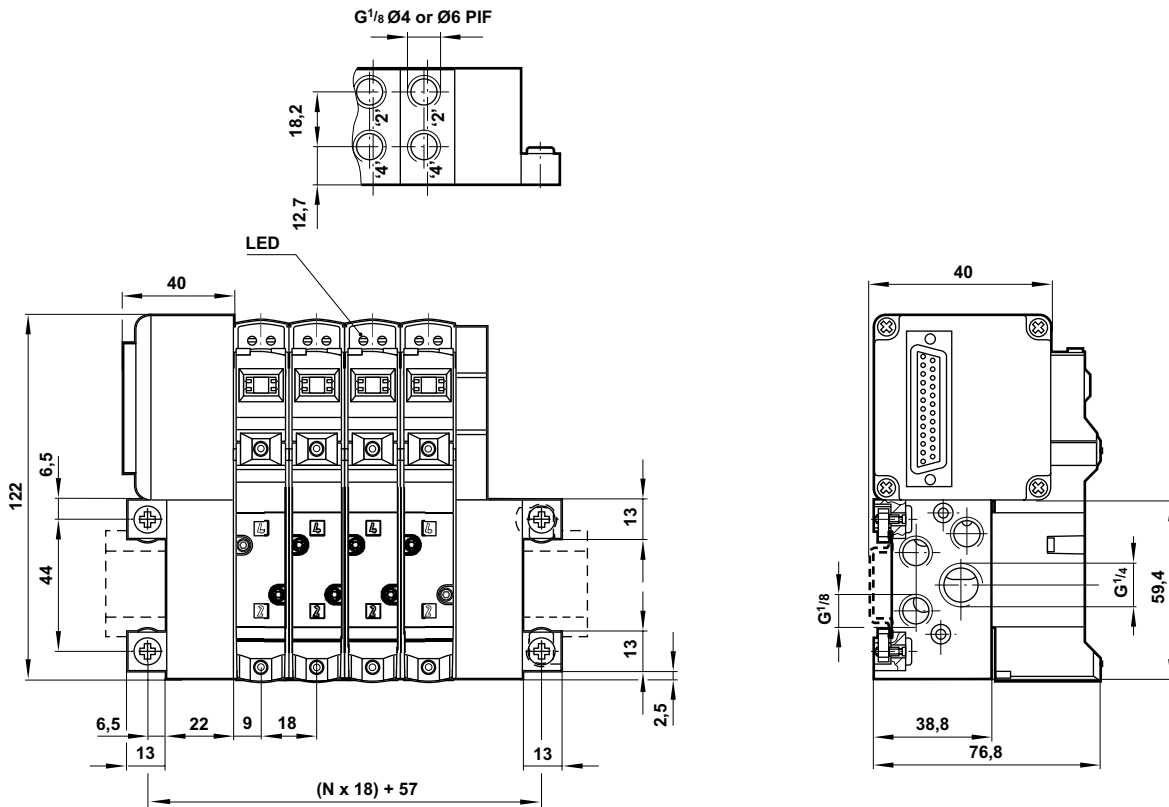

Electrical Connection Options

Left or Right Hand Side

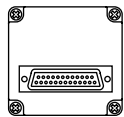

'D' Sub Connector

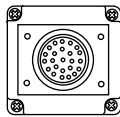

IP65 Round Connector

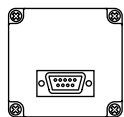

Local Bus*

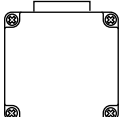

Top Mounted 25 pin 'D' Connector (Left Hand Only)



AS-I (4 Output)

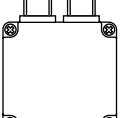

Remote Output (Right Hand Only)

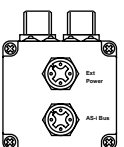

AS-I (2 Output, 2 Input)

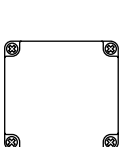

No Connection

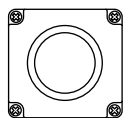

Conduit entry type (1" & M25)

* Used with Fieldbus II See Data Sheet 6.4.040



Multi-Pressure options –

Single pressure

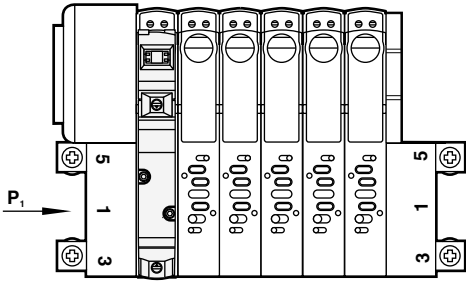

Dual pressure

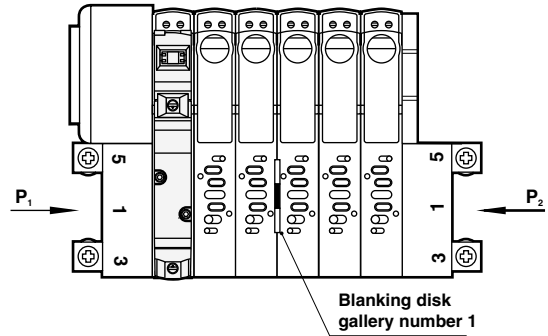

Three pressure

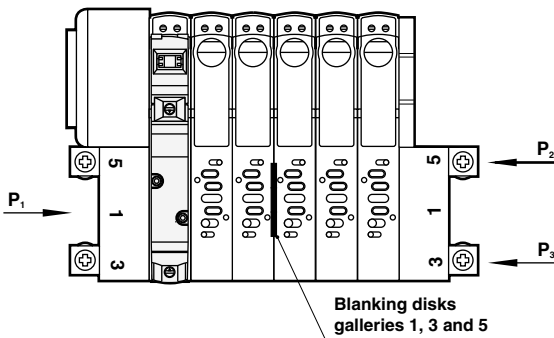

Four pressure

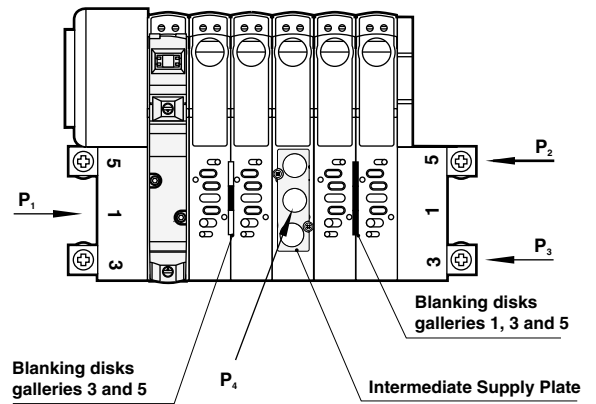

Five pressure

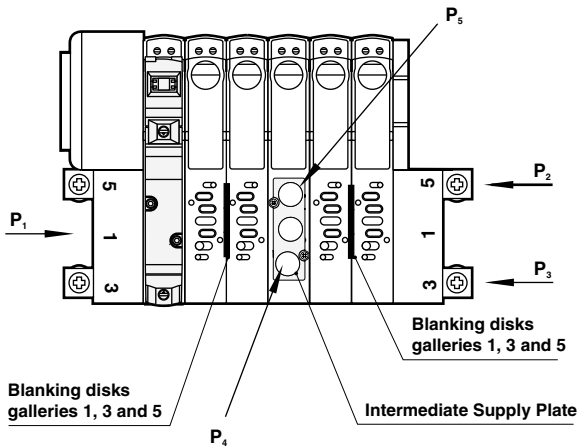

2 x Twin pressure

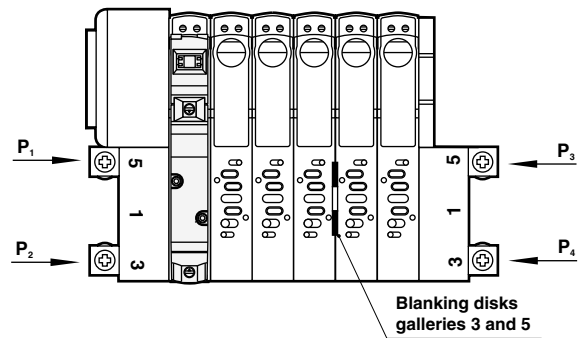

Blanking disk codes

Note: A blanking disk set is available under part no. V095516-Q1900 (A18).

Order Code: G1 (A20)



Gallery 1 blocked

Order Code: G3 (A19)



Gallery 3 & 5 blocked

Order Code: G5 (A21)



Gallery 1, 3 & 5 blocked

Valve island specification

Valve Island Specification Form VIP/.....

Company name Contact name

Address Tel no

..... Fax no

..... E-mail

Using the short order codes provided complete the build model below.

One valve island per sheet only

Unit ID No.
Norgren to specify

Valve range		Pneumatic port selection																															
V20	<input type="checkbox"/>	V09	<input type="checkbox"/>	G1/8	<input type="checkbox"/>	1/8 NPT	<input type="checkbox"/>	Side	<input type="checkbox"/>	4 mm PIF	<input type="checkbox"/>	6 mm PIF	<input type="checkbox"/>	No. of units required	<input type="checkbox"/>																		
V22	<input type="checkbox"/>	V14	<input type="checkbox"/>	G1/4	<input type="checkbox"/>	1/4 NPT	<input type="checkbox"/>	Side	<input type="checkbox"/>	Bottom	<input type="checkbox"/>	8 mm PIF	<input type="checkbox"/>	No. of stations required	<input type="checkbox"/>																		
Fieldbus diagnostic feature																																	
Yes <input type="checkbox"/> No <input type="checkbox"/>																																	
Accessory codes		<input type="text"/>																															
Accessory codes		<input type="text"/>																															
Valve codes		<input type="text"/>																															
DIN Rail mounting kit		Gasket codes <input type="text"/>																															
<table border="0" style="width:100%; text-align: center;"> <tr> <td></td> <td></td> <td></td> <td></td> <td></td> <td></td> <td></td> <td></td> <td></td> </tr> <tr> <td>IP40 'D' Sub connector</td> <td>IP65 Round connector</td> <td>Conduit entry</td> <td>IP40 'D' connector Top connection</td> <td>Local Bus (Fieldbus)</td> <td>AS-1 (4 output)</td> <td>AS-1 (2 in/2 out)</td> <td>Blank end</td> <td>Remote output</td> </tr> </table>																									IP40 'D' Sub connector	IP65 Round connector	Conduit entry	IP40 'D' connector Top connection	Local Bus (Fieldbus)	AS-1 (4 output)	AS-1 (2 in/2 out)	Blank end	Remote output
IP40 'D' Sub connector	IP65 Round connector	Conduit entry	IP40 'D' connector Top connection	Local Bus (Fieldbus)	AS-1 (4 output)	AS-1 (2 in/2 out)	Blank end	Remote output																									
Connection options																																	
V20 & V22 Voltage: Standard: 24 V d.c. negative common (Multipole & Fieldbus) <input type="checkbox"/>																																	
Options: Multipole 24 V d.c. positive common <input type="checkbox"/> 24 V a.c. <input type="checkbox"/>																																	
V09 & V14 Voltage: 6 V d.c. <input type="checkbox"/> 12 V d.c. <input type="checkbox"/> 24 V d.c. <input type="checkbox"/> 24 V a.c. <input type="checkbox"/> 48 V a.c. <input type="checkbox"/> 110 V a.c. <input type="checkbox"/> 240 V a.c. <input type="checkbox"/>																																	



IP40 D Sub-Connector

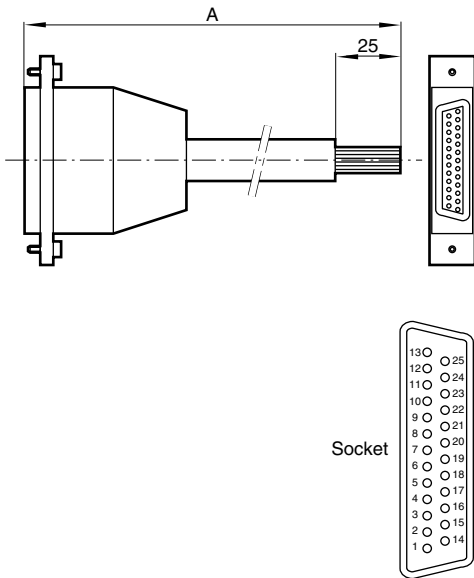

D-Sub connector with cable

Type: 25 pin IP40

Model	A	Weight (Kg)
V10020-E01	1,0 m	0,276
V10020-E03	3,0 m	0,676
V10020-E05	5,0 m	1,076

Pin no.	Socket	Plug	Pin no.	Socket	Plug
1	Solenoid 1	Red	14	Solenoid 14	Green/red
2	Solenoid 2	Blue	15	Solenoid 15	Yellow/red
3	Solenoid 3	Green	16	Solenoid 16	White/red
4	Solenoid 4	Yellow	17	Solenoid 17	Red/black
5	Solenoid 5	White	18	Solenoid 18	Red/brown
6	Solenoid 6	Brown	19	Solenoid 19	Yellow/blue
7	Solenoid 7	Violet	20	Solenoid 20	White/blue
8	Solenoid 8	Orange	21	Not used	Blue/black
9	Solenoid 9	Pink	22	Not used	Orange/blue
10	Solenoid 10	Turquoise	23	Not used	Yellow/green
11	Solenoid 11	Grey	24	Common -ve	White/green
12	Solenoid 12	Red/blue	25	Common -ve	Orange/green
13	Solenoid 13	Black			

Solenoid no. 1 is nearest to the connector on valve island

IP65 D Sub-Connector with seal

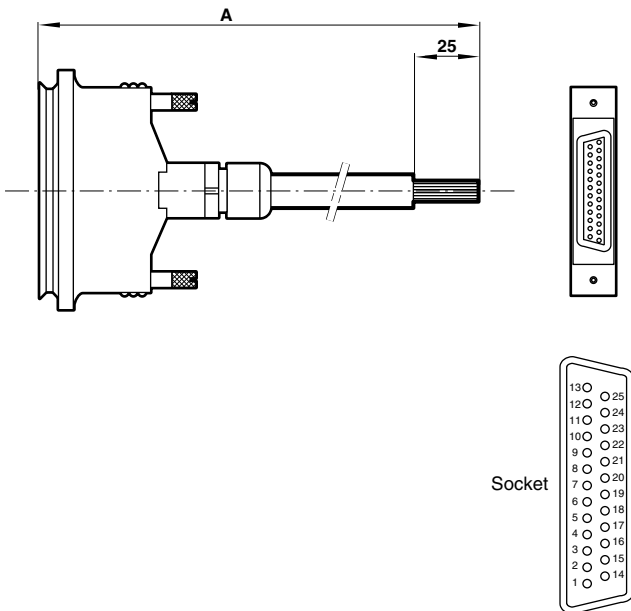

D-Sub connector with cable

Type: 25 pin IP65

Model	A	Weight (Kg)
V11063-E01	1,0 m	0,276
V11063-E03	3,0 m	0,676
V11063-E05	5,0 m	1,076

Pin no.	Socket	Plug	Pin no.	Socket	Plug
1	Solenoid 1	Red	14	Solenoid 14	Green/red
2	Solenoid 2	Blue	15	Solenoid 15	Yellow/red
3	Solenoid 3	Green	16	Solenoid 16	White/red
4	Solenoid 4	Yellow	17	Solenoid 17	Red/black
5	Solenoid 5	White	18	Solenoid 18	Red/brown
6	Solenoid 6	Brown	19	Solenoid 19	Yellow/blue
7	Solenoid 7	Violet	20	Solenoid 20	White/blue
8	Solenoid 8	Orange	21	Not used	Blue/black
9	Solenoid 9	Pink	22	Not used	Orange/blue
10	Solenoid 10	Turquoise	23	Not used	Yellow/green
11	Solenoid 11	Grey	24	Common -ve	White/green
12	Solenoid 12	Red/blue	25	Common -ve	Orange/green
13	Solenoid 13	Black			

Solenoid no. 1 is nearest to the connector on valve island

Blanking plate

V095516A-Q1100

Blanking plate for blocking off unwanted stations

*Note: A blanking plug part number V11060-K01 will also be required for the multipole sub-base when using a blanking plate.

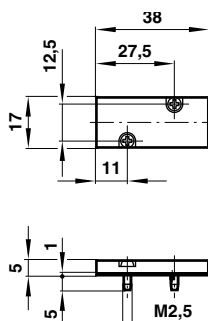



Intermediate supply/exhaust module

V095516A-Q160G (G1/8) 0,040 kg

Provides additional porting on modular Sub-base systems. Occupies one valve station. Supplied with gaskets for sub-base mounting.

Can be used to:

- Improve supply flow
- Increase exhaust capacity
- Pneumatically separate valves used on Valve Islands for fail safe in emergency
- Supply and exhaust twin supply valves

*Note: A blanking plug part number V11060-K01 will also be required for the multipole sub-base when using a blanking plate.

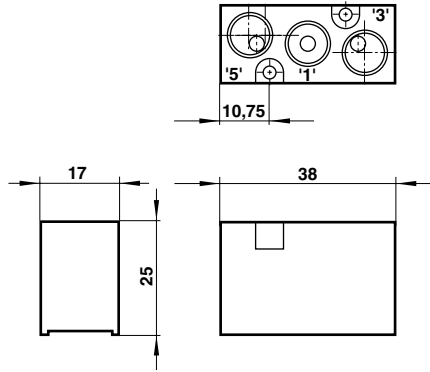

Pressure switch assembly

V095516A-Q1700 0,120 kg

Used in conjunction with a suitable P.L.C. based control system. Valves will not operate until the pressure on the valve island is above a pre-set level.

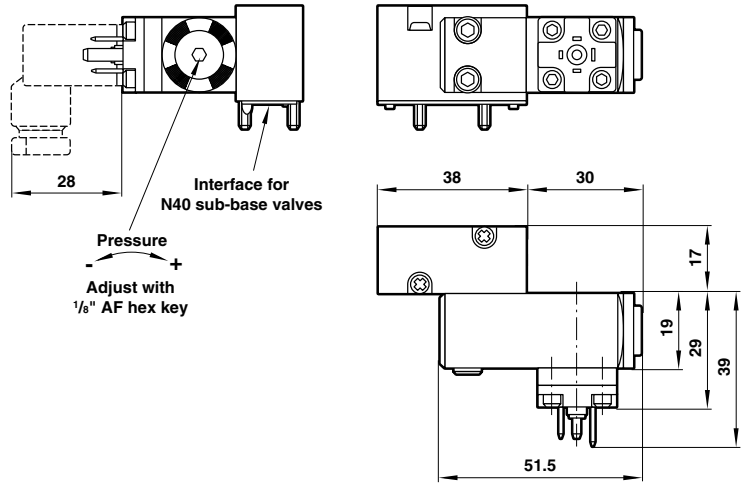

Sandwich pressure regulator

- V11270-K02 - Gauge inboard
- V11270-K03 - Gauge outboard

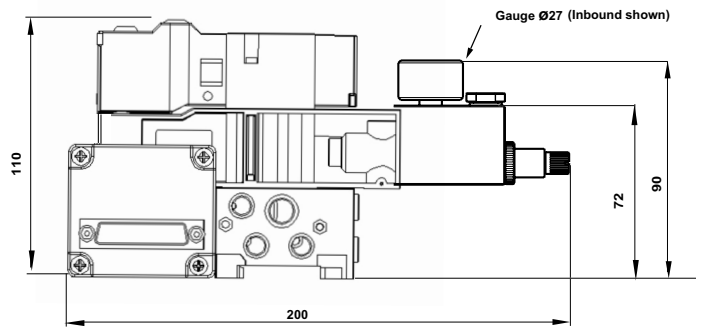
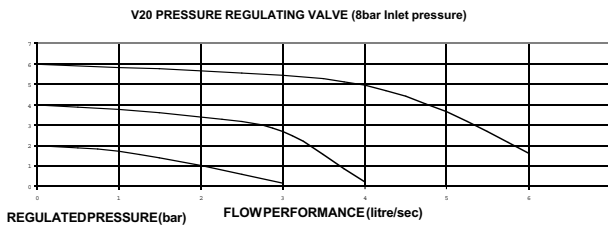

Circuit symbol

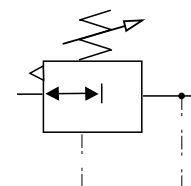

- Sandwich regulator:
- Regulates on port 1
 - Integral electrical connection
 - IP65
 - Gauge included



Remote output modules

Application:
 Remote output modules are used with valve islands to provide up to 4 outputs to remote devices such as soft start and monitored Dump valves.

V09, V20: 4 outputs VE2MP20B-00400

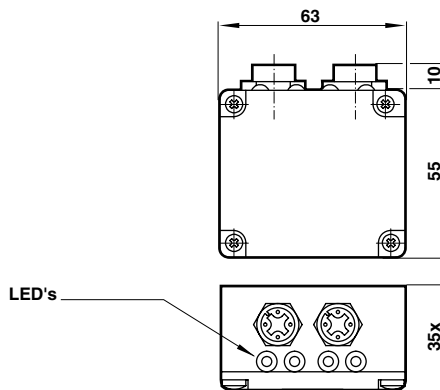

DIN Rail

V10009-C00
 1 metre

0,315 kg

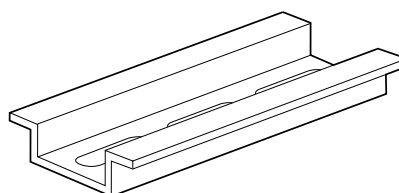

DIN Rail mounting kit

V10920-K01

0,008 kg

Kit for mounting side ported modular sub-bases on DIN 462277-3, BS5584 and CENELEC EN 50.0.22 mounting rail

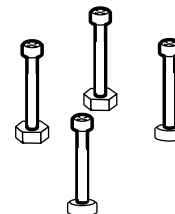

Blanking plug for unused multipole station

V11060-K01

Identification tabs

V11079-K01

Warning

These products are intended for use in industrial compressed air systems only. Do not use these products where pressures and temperatures can exceed those listed under **Technical Data**.
 Before using these products with fluids other than those specified, for non-industrial applications, life-support systems, or other applications not within published specifications, consult NORGREN.
 Through misuse, age, or malfunction, components used in fluid power systems can fail in various modes. The system designer is warned to consider the failure modes of all component parts used in fluid power systems and to provide adequate safeguards to prevent personal injury or damage to equipment in the event of such failure.
System designers must provide a warning to end users in the system instructional manual if protection against a failure mode cannot be adequately provided.
 System designers and end users are cautioned to review specific warnings found in instruction sheets packed and shipped with these products.