

- Assists in complying with safety regulations
- Tamper proof
- Compact and safe design
- Low pressure drop
- Automatically resets after failure correction
- High corrosion resistance
- High air pressure rating



Technical Data

Medium:

Compressed air, filtered, lubricated and non lubricated, inert gases.

Operation:

Fixed uni-directional excess flow automatic shut off valve.

Mounting:

In-line two way valve

To be inserted between fixed air supply and flexible hose air line

See guidelines for typical installation

Port Size: Female Thread

BSPP	NPT
G 1/4 T60C289*	1/4 NPT T60A289*
G 3/8 T60C389*	3/8 NPT T60A389*
G 1/2 T60C489*	1/2 NPT T60A489*
G 3/4 T60C689*	3/4 NPT T60A689*
G 1 T60C889*	1 NPT T60A889*
G 1 1/2 T60CB89*	1 1/2 NPT T60AB89*

* Last digit depends on flow range

Operating Pressure:

Maximum 16 bar

Minimum according to hose length

Drop pressure at shut-off flow . 0,14 or 0,3 bar.

Operating Temperature:

-20°C* to +80°C

* Consult our Technical Service for use below +2°C

At low temperature ensure fuse is not subjected to ice conditions which may prevent function.

Materials

Aluminium body, brass internal parts, stainless steel spring

Ordering Information

To order, quote appropriate product number from the tables on the following pages.
e.g. T60C2890 for the 1/4 BSPP with 0.14 bar drop pressure at shut off.

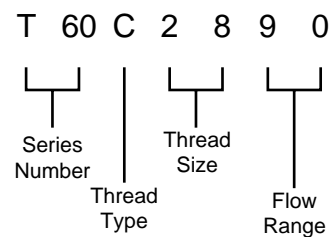

Simplified Symbol

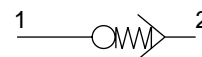

ISO Symbol

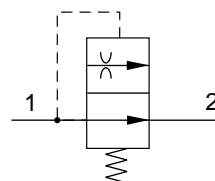



General Information

Model	Port size	Drop pressure at shut off flow (bar)	Shut off Flow rate at 7 bar (dm ³ /s) ±10%	Flow at 7 bar ΔP 0.07 bar (dm ³ /s)	Weight (Kg)
T60C2890	1/4	0,14	8,3	6,5	0,041
T60C2891	1/4	0,3	14	6,5	0,041
T60C3890	3/8	0,14	19,4	13,5	0,065
T60C3891	3/8	0,3	32,2	13,5	0,065
T60C4890	1/2	0,14	32,2	23,2	0,150
T60C4891	1/2	0,3	48,3	23,2	0,150
T60C6890	3/4	0,14	48,3	43	0,130
T60C6891	3/4	0,3	80	43	0,130
T60C8890	1	0,14	92	68	0,540
T60C8891	1	0,3	128	68	0,540
T60CB890	1 1/2	0,14	186	145	1,1
T60CB891	1 1/2	0,3	268	145	1,1

BSPP : according to BS2779 and ISO-228/1
 NPT : according to ANSI-B1.20.1.

Flow and pressure test conducted according to ISO-6358 test circuit. Mean measured flow values are provided at standard reference conditions.

Air Fuse

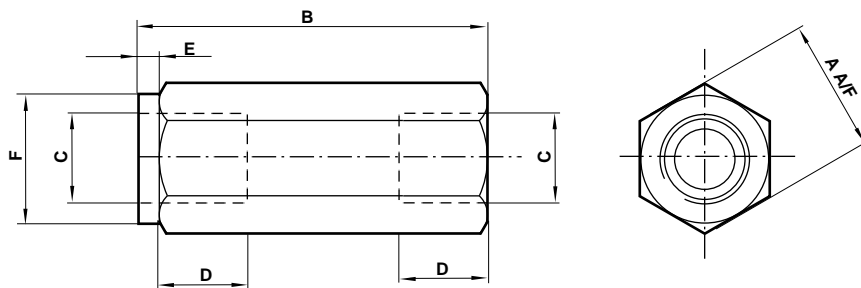

Model	T60C289* BSPP	T60A289* NPT	T60C389* BSPP	T60A389* NPT	T60C489* BSPP	T60A489* NPT	T60C689* BSPP	T60A689* NPT	T60C889* BSPP	T60A889* NPT	T60CB89* BSPP	T60AB89* NPT
A	20,6	20,6	24	24	31,75	31,75	31,75	31,75	50,8	50,8	63,5	63,5
B	51	51	62	62	78	78	90	90	118	118	145	145
C	1/4	1/4	3/8	3/8	1/2	1/2	3/4	3/4	1	1	1 1/2	1 1/2
D	11	10	14	10,3	15	13,6	19	14,1	25,5	16,8	25,5	17,3
E	3	3	5	5	5	5	5	5	5	5	5	5
F	20,6	20,6	24	24	31,75	31,75	31,75	31,75	50,8	50,8	63,5	63,5



Guidelines for Typical Installation

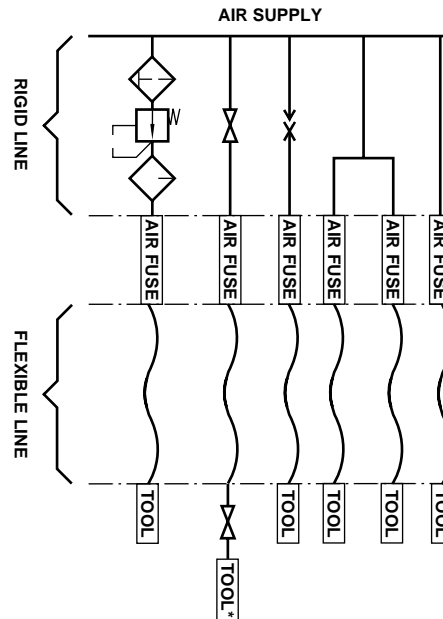

The Air Fuse should be installed directly between fixed or rigid pipework and the flexible tube to protect the whole length of the flexible tube. Only tubing after the Air Fuse is protected. The Air Fuse must be installed in the correct direction for Airflow. Failure to do this will render the Air Fuse ineffective. When a shut off valve is located before the Air Fuse, the valve must be opened slowly in order to control initial air flow and avoid decompression effects which may trip the Air Fuse.

How to Select an Air Fuse

- a) The Port size of the Air Fuse should be nominally equal to that of the supply lines - eg a 1/2" (12.7mm) Air Fuse should be used with a 1/2" (12.7mm) ID hose.
- b) Always select the high flow model (91) if there is sufficient system pressure for the length of hose to be protected. See tables hose length vs minimum supply pressure.
- c) If there is insufficient system pressure, or long hose lengths are to be protected, use model 90.
- d) After installation always test each valve for proper function. See section how to check an Air Fuse below.
- e) The pneumatic system must be capable of delivering the flow required to activate the Air Fuse.
- f) For use with spring coils consult table. See table flow vs pressure supply.

How to Check an Air Fuse

- * Install Air Fuse following the instructions supplied
- * Connect tool or complete circuit to the air line
- * Switch on operation to ensure a complete cycle is performed
- * If tool or complete circuit starts and runs satisfactorily, stop operation and drain air line. Disconnect hose from tool or circuit and secure hose end. Turn on air supply progressively (to avoid decompression effect). Prior to fully reaching operation conditions, the valve should suddenly activate and cut off the flow. A slight air flow will remain as part of the automatic re-set function. If the Air fuse is not activated the unit should be disconnected and the lower flow range Air Fuse should be used.



Minimum Pressure Required To Shut Off The Air Supply - Check Failure Flow Conditions

Hose length vs minimum pressure supply (1/4" to 3/8")

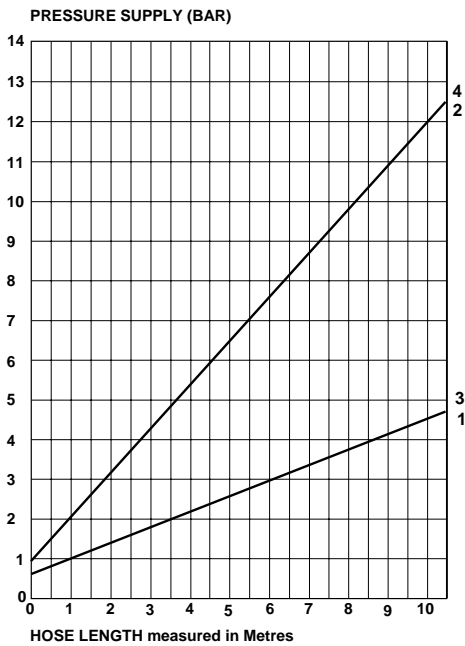

- KEY**
- 1 - T60 * 2890 (ID = 6,6mm)
 - 2 - T60 * 2891 (ID = 6,6mm)
 - 3 - T60 * 3890 (ID = 9,0mm)
 - 4 - T60 * 3891 (ID = 9,0mm)

Hose length vs minimum pressure supply (1/2" to 3/4")

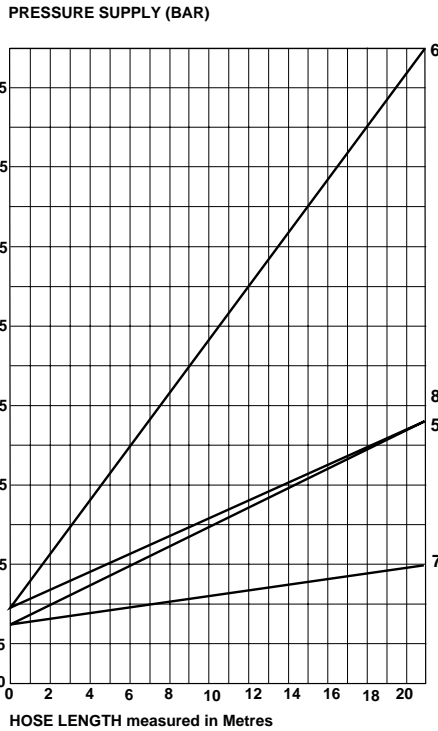

- KEY**
- 5 - T60 * 4890 (ID = 13mm)
 - 6 - T60 * 4891 (ID = 13mm)
 - 7 - T60 * 6890 (ID = 19mm)
 - 8 - T60 * 6891 (ID = 19mm)

Hose length vs minimum pressure supply (1 to 1 1/2")

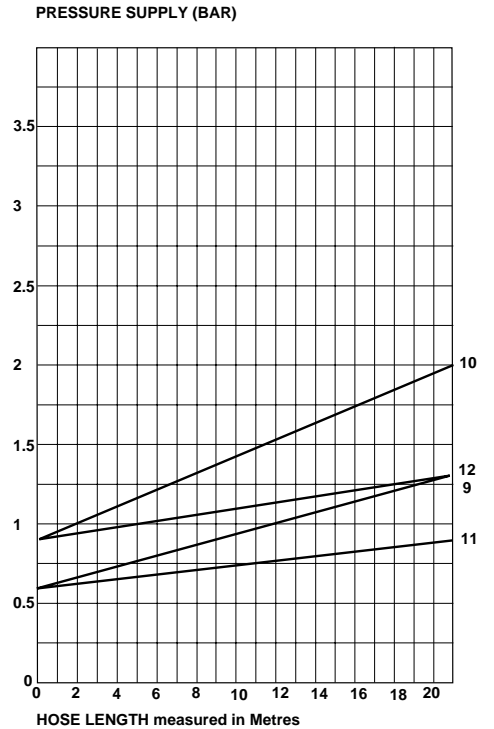

- KEY**
- 9 - T60 * 8890 (ID = 25,4mm)
 - 10 - T60 * 8891 (ID = 25,4mm)
 - 11 - T60 * B890 (ID = 38,1mm)
 - 12 - T60 * B891 (ID = 38,1mm)

Flow Required To Shut Off Air Supply - Check Normal Flow Conditions

Flow (±10%) vs pressure supply (1/4" to 1/2")

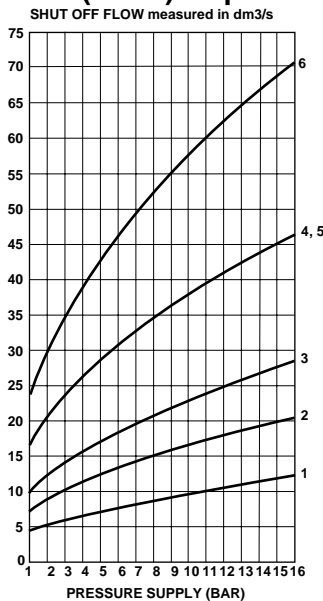

- KEY**
- 1 - T60 * 2890
 - 2 - T60 * 2891
 - 3 - T60 * 3890
 - 4 - T60 * 3891
 - 5 - T60 * 4890
 - 6 - T60 * 4891

Flow (±10%) vs pressure supply (3/4" to 1 1/2")

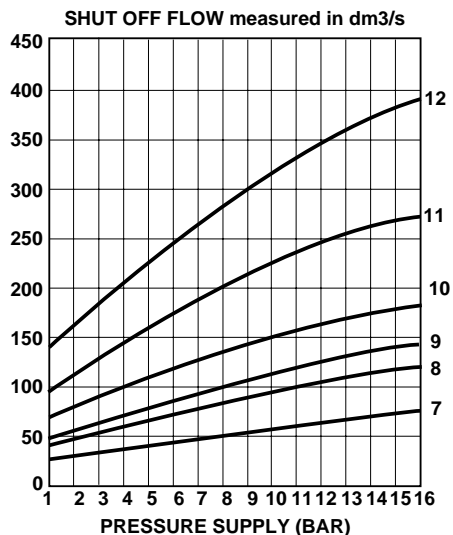

- KEY**
- 7 - T60 * 6890
 - 8 - T60 * 6891
 - 9 - T60 * 8890
 - 10 - T60 * 8891
 - 11 - T60 * B890
 - 12 - T60 * B891

Measurements

- Flow and pressure tests conducted according to ISO-6358 test circuit
- Mean measured flow values are provided at standard reference condition (20°C, 1,01 bar)
- Indicated pressure values are relative pressure in bar.

Hose Lengths

- Graphs are for indicated hose internal diameter in key.
- Consult our Technical Service for hose lengths and internal diameters different from the recommended one.



Air Fuses for use with Norgren Spring Coils

Minimum Required Pressure (bar) to ensure shut off should hose fail

Spring Coils Part Number	Air Fuse					
	T60C2890	T60C2891	T60C3890	T60C3891	T60C4890	T60C4891
PA330600328						
PA330600428						
PA330600528						
PA330600828						
PA330601528						
PA330800328	4,1					
PA330800428	5,4					
PA330800528						
PA330800828						
PA330801528						
PA331000328	1,0	2,5	4,8			
PA331000428	1,2	3,3	6,4			
PA331000528	1,5	4,2				
PA331000828	2,2	6,2				
PA331001528	4,4					
PA331200338	0,7	0,9	1,5	4,1		
PA331200438	0,7	1,0	2,0	5,4		
PA331200538	0,7	1,3	2,4			
PA331200838	0,7	1,9	3,7			
PA331201538	1,4	3,8				
PA331500348	0,7	0,9	0,7	1,5	1,5	3,5
PA331500448	0,7	0,9	0,7	2,1	2,1	4,6
PA331500548	0,7	0,9	0,9	2,6	2,6	5,8
PA331500848	0,7	0,9	1,4	3,8	3,8	
PU310600218						
PU310600418						
PU310600618						
PU310600818						
PU310800228	5,4					
PU310800428						
PU310800628						
PU310800828						
PU311000228	1,3	3,8				
PU311000428	2,7					
PU311000628	5,0					
PU311000828	6,0					
PU311200238	0,7	1,2	2,4	6,6		
PU311200438	0,9	2,5	4,8			
PU311200638	1,3	3,7				
PU311200838	1,6	4,6				

NOTE: Where no figure is shown these coils can not be protected by the Norgren Air Fuse

Warning

These products are intended for use in industrial compressed air systems only. Do not use these products where *pressures* and *temperatures* can exceed those listed under 'Technical Data'.

Before using these products with fluids other than those specified, for non-industrial applications, life-support systems, or other applications not within published specifications, consult Norgren.

Through misuse, age, or malfunction, components used in fluid power systems can fail in various modes. The system designer is warned to consider the failure modes of all component parts used in fluid power systems and to provide adequate safeguards to prevent personal injury or damage to equipment in the event of such failure.

System designers must provide a warning to end users in the system instructional manual if protection against a failure mode cannot be adequately provided.

System designers and end users are cautioned to review specific warnings found in instruction sheets packed and shipped with these products where applicable.