

- 1 **Rugged and durable**
- 1 **Ideal for most industrial applications**
- 1 **Wide range of types and sizes**
- 1 **Tube O/D sizes 4mm to 22mm**
- 1 **Thread sizes from 1/8" to 1" BSP**
- 1 **Supplied assembled with tubing sleeves, nuts and appropriate seals**

## Technical Data

### Medium:

These fittings are designed for use with compressed air, oils, water and other fluids used in pneumatic and low pressure hydraulic applications.

\*Consult our Technical Service for details.

### Operating Pressure:

The maximum working pressure is limited by the type of tubing being used.

### Operating Temperature:

The maximum working temperature is limited by the type of tubing being used.

### Tubing:

Nylon 11 or 12 and other plasticised or un plasticised tubing and other soft plastic tubing.

Copper, annealed and half-hard.

Double wall brazed steel tube to dimensions laid out in Section 9.12.

### Tube Sizes

4, 6, 8, 10, 12, 14, 15, 16, 18, 22 mm O/D

### Thread Sizes

BSP - 1/8, 1/4, 3/8, 1/2, 3/4, 1

Threads used on products conform to:

ISO 7.1	-	Taper BSP
ISO 228	-	Parallel BSP
ISO R/226	-	Metric

### Materials

Brass to OT 58 UNI 5705 for all items, except plastic washers.

Plastic washers - nylon

All brass items have a nickel plated finish unless otherwise stated.



## Ordering Information

To order, quote appropriate product number from the tables on the following pages. The fittings are supplied complete with all nuts, universal tubing sleeves, seals and washers.



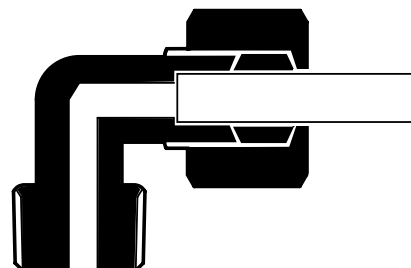















Conical tubing sleeves and matching nuts and tube supports are also available.









## Compression Fittings 43 Series Metric External Nut

### Connectors and Adaptors

<b>TUBING PLUG</b> Male O/D tube thread  43 004  Page 9.6.004.04	<b>STEM TAILPIECE CONNECTOR</b> O/D stem to hose bore  43 019  Page 9.6.004.04	<b>STRAIGHT STEM ADAPTOR</b> O/D tube stem to male parallel BSP thread  43 215  Page 9.6.004.04	<b>REDUCING CONNECTOR</b> O/D tube to O/D tube  43 028  Page 9.6.004.04	<b>BULKHEAD CONNECTOR</b> O/D tube  43 029  Page 9.6.004.05	<b>STRAIGHT CONNECTOR</b> O/D tube  43 020  Page 9.6.004.05	<b>STRAIGHT MALE ADAPTOR</b> O/D tube to male taper BSP thread  43 125  Page 9.6.004.05
<b>STRAIGHT MALE ADAPTOR</b> O/D tube to male parallel BSP thread  43 225  Page 9.6.004.06	<b>STRAIGHT FEMALE ADAPTOR</b> O/D tube to female parallel thread  43 226  Page 9.6.004.06	<b>ELBOW CONNECTOR</b> O/D tube  43 040  Page 9.6.004.06	<b>MALE ELBOW ADAPTOR</b> O/D tube to male taper BSP thread  43 145  Page 9.6.004.07	<b>TEE CONNECTOR</b> O/D tube  43 060  Page 9.6.004.08	<b>MALE TEE ADAPTOR</b> O/D tube to male taper BSP thread  43 165  Page 9.6.004.08	<b>MALE SIDE TEE ADAPTOR</b> O/D tube to male taper BSP thread  43 175  Page 9.6.004.08
<b>FOUR WAY CONNECTOR</b> O/D tube  43 090  Page 9.6.004.09	<b>SINGLE BANJO BODY</b> O/D tube  43 051  Page 9.6.004.09	<b>BANJO BOLT</b>  43 A00  Page 9.6.004.09	<b>ELBOW BANJO ASSEMBLY</b> Non regulating BSPP bolt O/D tube to male parallel BSP thread  43 A51  Page 9.6.004.09			

### Nuts and Sleeves

<b>UNIVERSAL TUBING SLEEVE</b>  43 002  Page 9.6.004.010	<b>TUBING NUT</b>  43 001  Page 9.6.004.010	<b>CONICAL TUBING SLEEVE</b>  43 003  Page 9.6.004.010	<b>CONICAL TUBING NUT</b>  43 034  Page 9.6.004.010	<b>TUBE SUPPORT</b>  43 033  Page 9.6.004.011		
---	--	---	--	--	--	--



## Assembly Details

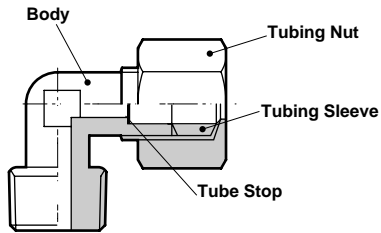

## Method of Assembly

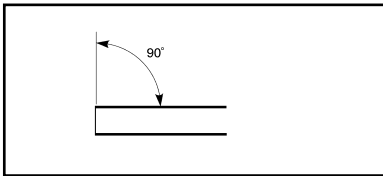

1. Ensure that the tube is cut square and is free from fraze.

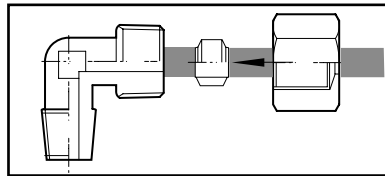

2. For larger sizes of metal tubes it is beneficial to lightly oil the tubing nut and sleeve before tightening the joint. Place the tubing nut and sleeve on the tube and push the tube into the fitting until it bottoms on the tube stop.

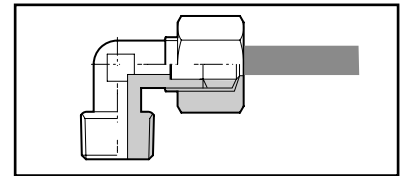

3. Holding the tube firmly in contact with the tube stop screw the tubing nut down finger tight and then tighten a further  $1\frac{1}{4}$  -  $1\frac{1}{2}$  full turns. Slacken off the assembly and ensure that the groove made by sleeve is even. Release nut and re-tighten nut an extra quarter turn.

### Note

When fitting to curved tubes ensure that section entering the fitting is straight for a minimum of twice the nut height. The method of preparation and assembly described will ensure leak-proof joints over a wide pressure range, depending upon the size and type of tubing being used. Failure to follow this guide, or over-tightening at any joint, may lead to damage of the fittings or an unsatisfactory seal.



## Compression Fittings 43 Series Metric External Nut

### Tubing Plug

Male O/D tube thread

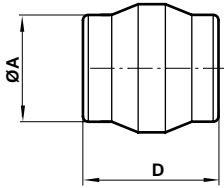

Product number	A O/D	D
43 004 0400	4	10,0
43 004 0600	6	10,5
43 004 0800	8	10,5
43 004 1000	10	11,5
43 004 1200	12	12,0
43 004 1400	14	14,0
43 004 1500	15	14,0
43 004 1600	16	14,0
43 004 1800	18	16,0
43 004 2200	22	15,0

Natural Brass Finish

### Stem Tailpiece Connector

O/D stem to hose bore

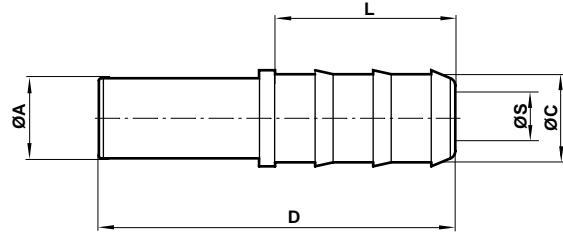

Product number	A O/D stem	C hose bore	D	L	S
43 019 0607	6	7	40,5	22,5	5,5
43 019 0807	8	7	43,5	22,5	5,5
43 019 0810	8	10	43,5	22,5	8,0
43 019 1007	10	7	44,5	22,5	5,5
43 019 1010	10	10	44,5	22,5	8,0
43 019 1210	12	10	45,0	22,5	8,0
43 019 1213	12	13	52,0	29,5	11,0
43 019 1413	14	13	52,5	29,5	11,5

Natural Brass Finish

### Straight Stem Adaptor

O/D tube stem to male parallel BSP thread

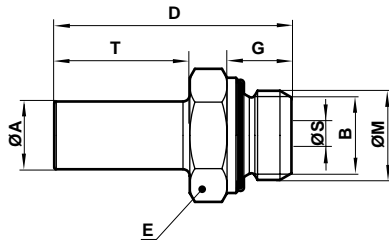

Product number	A O/D stem	B BSPP	D	E A/F	G	M	S	T
43 215 0618	6	1/8	27,5	10	6,5	14	4,0	16
43 215 0628	6	1/4	31,0	13	8,0	18	4,0	16
43 215 0818	8	1/8	31,5	14	6,5	14	5,5	19
43 215 0828	8	1/4	34,0	19	8,0	18	6,0	19
43 215 0838	8	3/8	38,0	22	11,0	21	6,0	19
43 215 1028	10	1/4	35,0	24	8,0	18	8,0	20
43 215 1038	10	3/8	39,0	24	11,0	21	8,0	20
43 215 1438	14	3/8	40,0	27	11,0	21	11,0	21
43 215 1448	14	1/2	42,0	30	12,0	26	12,0	21

### Reducing Connector

O/D tube to O/D tube

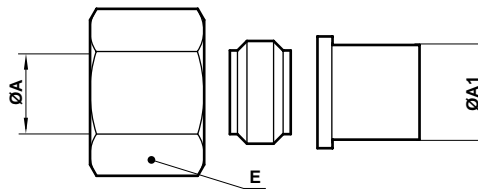

Product number	A1 O/D tube	A O/D tube	E A/F
43 028 0604	6	4	13
43 028 0806	8	6	14
43 028 1008	10	8	19
43 028 1210	12	10	22
43 028 1412	14	12	24

Natural Brass Finish for Sleeve and Reducer.



### Bulkhead Connector

O/D tube

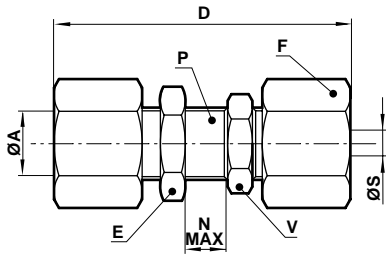

Product number	A O/D tube	D	E A/F	F A/F	N Max b/head	P thread	S	V A/F
43 029 0400	4	49	13	10	12,0	M 8 x 1,0	3,0	13
43 029 0600	6	53	14	13	12,5	M10 x 1,0	4,5	13
43 029 0800	8	57	17	14	12,5	M12 x 1,0	6,0	14
43 029 1000	10	64	22	19	13,0	M16 x 1,5	8,0	19
43 029 1200	12	70	22	22	17,0	M18 x 1,5	10,0	22
43 029 1400	14	72	24	24	19,0	M20 x 1,5	12,0	24

Minimum Bulkhead thickness 3,0

### Straight Connector

O/D tube

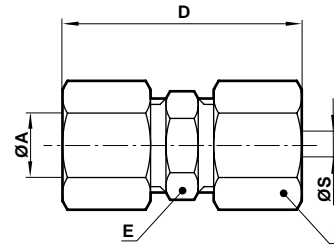

Product number	A O/D tube	D	E A/F	F A/F	S
43 020 0400	4	33,0	10	10	3,0
43 020 0600	6	36,0	11	13	4,5
43 020 0800	8	40,0	13	14	6,0
43 020 1000	10	45,5	16	19	8,0
43 020 1200	12	46,5	18	22	10,0
43 020 1400	14	47,0	21	24	12,0
43 020 1500	15	51,0	21	24	12,0
43 020 1600	16	52,0	22	27	15,0
43 020 1800	18	54,0	26	30	17,0
43 020 2200	22	57,0	30	36	20,0

### Straight Male Adaptor

O/D tube to male taper BSP thread

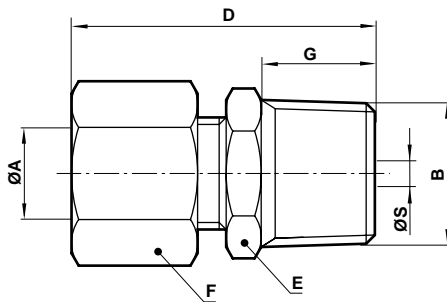

Product number	A O/D tube	B thread BSP	D	E A/F	F A/F	G	S
43 125 0418	4	1/8	26,5	11	11	7,5	3,0
43 125 0428	4	1/4	29,5	14	10	11,0	3,0
43 125 0618	6	1/8	28,0	11	13	7,5	4,5
43 125 0628	6	1/4	31,5	14	13	11,0	4,5
43 125 0638	6	3/8	32,0	17	13	11,5	4,5
43 125 0818	8	1/8	30,0	13	14	7,5	6,0
43 125 0828	8	1/4	33,5	14	14	11,0	6,0
43 125 0838	8	3/8	34,0	17	14	11,5	6,0
43 125 1028	10	1/4	36,0	16	19	11,0	8,0
43 125 1038	10	3/8	36,5	17	19	11,5	8,0
43 125 1048	10	1/2	38,0	21	19	13,0	8,0
43 125 1228	12	1/4	36,5	18	22	11,0	8,0
43 125 1238	12	3/8	37,0	18	22	11,5	10,0
43 125 1248	12	1/2	38,5	21	22	13,0	10,0
43 125 1438	14	3/8	38,5	20	24	11,5	11,0
43 125 1448	14	1/2	39,5	21	24	13,0	12,0
43 125 1548	15	1/2	39,5	21	24	13,0	12,0
43 125 1648	16	1/2	42,0	22	27	13,0	15,0
43 125 1668	16	3/4	43,5	27	27	14,5	15,0
43 125 1848	18	1/2	42,5	24	30	13,0	15,0
43 125 1868	18	3/4	44,0	27	30	14,5	17,0
43 125 2248	22	1/2	45,0	30	36	13,0	15,0
43 125 2268	22	3/4	46,5	30	36	14,5	20,0



## Compression Fittings

### 43 Series Metric External Nut

#### Straight Male Adaptor

O/D tube to male parallel BSP thread

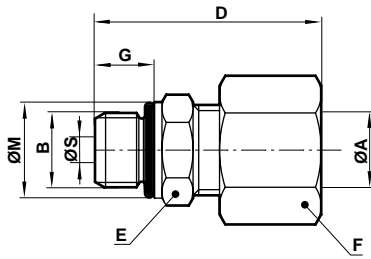

Product number	A O/D tube	B thread BSP	D	E A/F	F A/F	G	M	S
43 225 0418	4	1/8	26,0	13	10	7,5	14	3,0
43 225 0618	6	1/8	27,0	13	13	7,5	14	4,5
43 225 0628	6	1/4	30,5	17	13	9,5	18	4,5
43 225 0818	8	1/8	30,0	13	14	7,5	14	5,0
43 225 0828	8	1/4	32,5	17	14	9,5	18	6,0
43 225 0838	8	3/8	36,5	22	14	13,0	21	6,0
43 225 1028	10	1/4	35,0	17	19	9,5	18	8,0
43 225 1038	10	3/8	39,0	22	19	13,0	21	8,0
43 225 1438	14	3/8	39,5	22	24	13,0	21	11,0
43 225 1448	14	1/2	41,5	27	24	14,5	26	12,0
43 225 2268	22	3/4	48,0	32	36	15,5	33	18,0
43 225 2288	22	1	51,0	41	36	17,5	41	20,0

#### Straight Female Adaptor

O/D tube to female parallel BSP thread

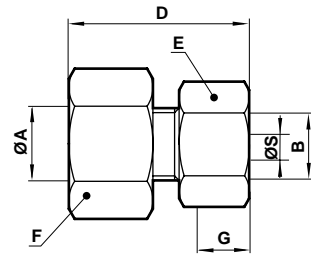

Product number	A O/D tube	B thread BSP	D	E A/F	F A/F	G	S
43 226 0418	4	1/8	25,0	14	10	8,5	3,0
43 226 0618	6	1/8	26,0	14	13	8,5	4,5
43 226 0628	6	1/4	28,5	17	13	11,0	4,5
43 226 0818	8	1/8	28,0	14	14	8,5	6,0
43 226 0828	8	1/4	30,5	17	14	11,0	6,0
43 226 0838	8	3/8	31,0	20	14	11,5	6,0
43 226 1028	10	1/4	33,0	17	19	11,0	8,0
43 226 1038	10	3/8	33,5	20	19	11,5	8,0
43 226 1048	10	1/2	35,5	24	19	13,5	8,0
43 226 1228	12	1/4	33,5	18	22	11,0	10,0
43 226 1238	12	3/8	34,0	20	22	11,5	10,0
43 226 1248	12	1/2	36,0	24	22	13,5	10,0
43 226 1438	14	3/8	33,5	20	24	11,5	12,0
43 226 1448	14	1/2	36,0	24	24	13,5	12,0
43 226 1548	15	1/2	36,5	24	24	13,5	12,0
43 226 1648	16	1/2	38,5	24	27	13,5	15,0
43 226 1668	16	3/4	40,0	30	27	14,5	15,0
43 226 1848	18	1/2	39,0	24	30	13,5	17,0
43 226 1868	18	3/4	40,5	30	30	14,5	17,0
43 226 2268	22	3/4	41,0	30	36	14,5	20,0

#### Elbow Connector

O/D tube

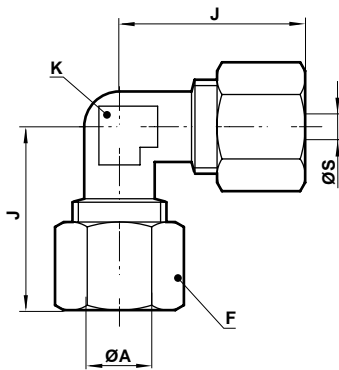

Product number	A O/D tube	F A/F	J	K A/F	S
43 040 0400	4	10	21,5	8	3,0
43 040 0600	6	13	26,0	9	4,5
43 040 0800	8	14	30,0	11	6,0
43 040 1000	10	19	33,0	13	8,0
43 040 1200	12	22	35,5	14	10,0
43 040 1400	14	24	36,5	17	12,0
43 040 1500	15	24	37,5	17	12,0
43 040 1600	16	27	39,0	17	15,0
43 040 1800	18	30	40,5	20	17,0
43 040 2200	22	36	43,0	27	20,0



## Male Elbow Adaptor

O/D tube to male taper BSP thread

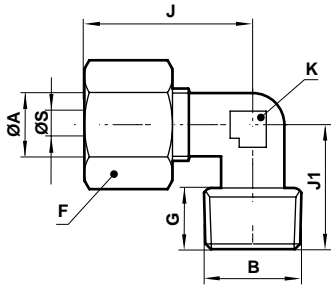

Product number	A O/D tube	B thread BSP	F A/F	G	J	J1	K A/F	S
43 145 0418	4	1/8	10	7,5	21,5	15,0	8	3,0
43 145 0618	6	1/8	13	7,5	26,0	18,0	9	4,5
43 145 0628	6	1/4	13	11,0	24,0	19,0	9	4,5
43 145 0818	8	1/8	14	7,5	30,0	18,0	11	6,0
43 145 0828	8	1/4	14	11,0	30,0	22,0	11	6,0
43 145 0838	8	3/8	14	11,5	30,5	24,0	13	6,0
43 145 1028	10	1/4	19	11,0	33,0	23,5	13	8,0
43 145 1038	10	3/8	19	11,5	33,0	24,0	13	8,0
43 145 1048	10	1/2	19	13,0	35,0	25,0	14	8,0
43 145 1228	12	1/4	22	11,0	35,5	24,0	14	10,0
43 145 1238	12	3/8	22	11,5	35,5	24,5	14	10,0
43 145 1248	12	1/2	22	13,0	35,5	25,0	14	10,0
43 145 1438	14	3/8	24	11,5	38,5	26,0	17	11,0
43 145 1448	14	1/2	24	13,0	38,5	28,5	17	12,0
43 145 1548	15	1/2	24	13,0	38,5	28,5	17	12,0
43 145 1648	16	1/2	27	13,0	39,5	28,0	17	15,0
43 145 1848	18	1/2	30	13,0	40,5	29,5	20	17,0
43 145 1868	18	3/4	30	11,5	40,5	32,0	20	17,0
43 145 2268	22	3/4	36	11,5	43,0	34,0	27	20,0



## Compression Fittings

### 43 Series Metric External Nut

#### Tee Connector

O/D tube

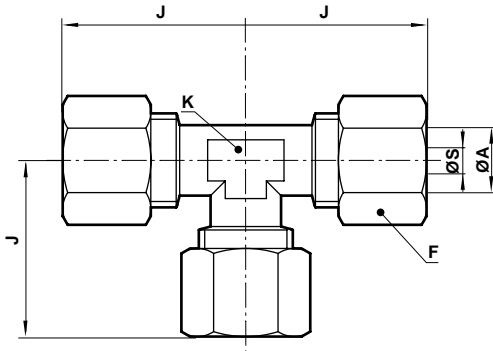

#### Male Tee Adaptor

O/D tube to male taper BSP thread

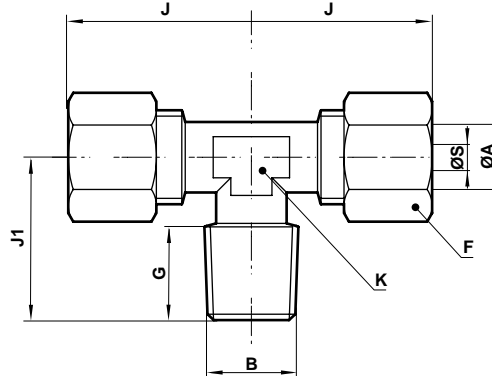

Product number	A O/D tube	F A/F	J	K A/F	S
43 060 0400	4	10	21,5	8	3,0
43 060 0600	6	13	24,0	9	4,5
43 060 0800	8	14	28,5	12	6,0
43 060 1000	10	19	32,0	13	8,0
43 060 1200	12	22	35,0	14	10,0
43 060 1400	14	24	38,5	18	12,0
43 060 1500	15	24	38,5	18	12,0
43 060 1600	16	27	39,0	17	15,0
43 060 1800	18	30	40,5	20	17,0
43 060 2200	22	36	43,0	27	20,0

Product number	A O/D tube	B thread BSP	F A/F	G	J	J1	K A/F	S
43 165 0418	4	1/8	10	7,5	21,0	15,0	8	3,0
43 165 0618	6	1/8	13	7,5	24,0	16,5	9	4,5
43 165 0628	6	1/4	13	11,0	24,0	20,5	9	4,5
43 165 0818	8	1/8	14	7,5	28,0	16,5	12	6,0
43 165 0828	8	1/4	14	11,0	28,0	20,5	12	6,0
43 165 0838	8	3/8	14	11,5	30,0	23,0	13	6,0
43 165 1028	10	1/4	19	11,0	32,0	22,5	13	8,0
43 165 1038	10	3/8	19	11,5	32,0	23,5	13	8,0
43 165 1048	10	1/2	19	13,0	34,0	27,0	14	8,0
43 165 1228	12	1/4	22	11,0	34,0	24,5	14	10,0
43 165 1238	12	3/8	22	11,5	35,5	24,5	14	10,0
43 165 1248	12	1/2	22	13,0	35,5	25,0	14	10,0
43 165 1438	14	3/8	24	11,5	38,5	26,0	17	11,0
43 165 1448	14	1/2	24	13,0	38,5	28,5	17	12,0
43 165 1548	15	1/2	24	13,0	38,5	28,5	17	12,0
43 165 1648	16	1/2	27	13,0	39,5	28,0	17	15,0
43 165 1848	18	1/2	30	13,0	40,5	29,5	20	15,0
43 165 1868	18	3/4	30	14,5	40,5	32,0	20	17,0
43 165 2268	22	3/4	36	11,5	43,0	34,0	27	20,0

#### Male Side Tee Adaptor

O/D tube to male taper BSP thread

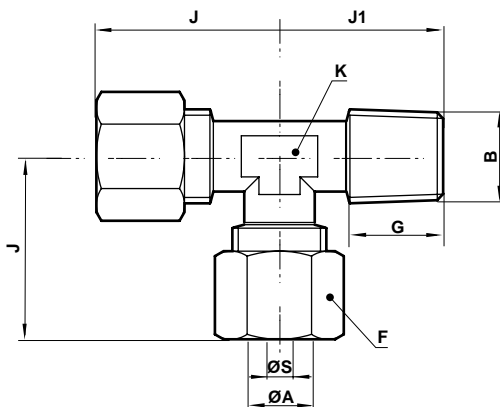

Product number	A O/D tube	B thread BSP	F A/F	G	J	J1	K A/F	S
431750418	4	1/8	10	7,5	21	15	8	3,0
431750618	6	1/8	13	7,5	24	19	9	4,5
431750628	6	1/4	13	11,0	26	20	9	4,5
431750818	8	1/8	14	7,5	26	18	12	6,0
431750828	8	1/4	14	11,0	26	20	12	6,0
431750838	8	3/8	14	11,5	26	23	13	6,0





### Four Way Connector

O/D tube

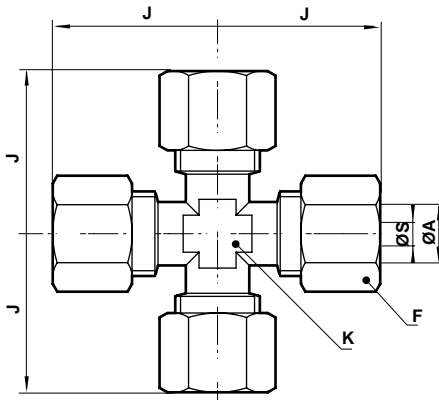

Product number	A O/D tube	F A/F	J	K A/F	S
43 090 0400	4	10	23	8	3,0
43 090 0600	6	13	24	8	4,5
43 090 0800	8	14	29	11	6,0
43 090 1000	10	19	33	13	8,0
43 090 1200	12	22	37	17	10,0
43 090 1400	14	24	37	17	12,0

### Elbow Banjo Assembly

Non Regulating BSPP Bolt

O/D tube to male parallel BSP thread

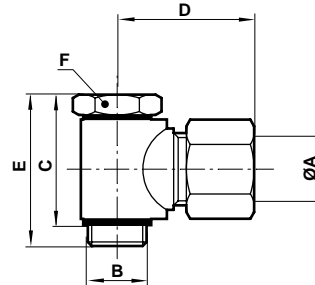

Product number	A O/D tube	B thread BSPP	C	D	E	F A/F
43 A51 0418	4	1/8	24,5	22,5	31,0	14
43 A51 0618	6	1/8	24,5	23,5	31,0	14
43 A51 0628	6	1/4	25,0	26,5	32,0	17
43 A51 0818	8	1/8	24,5	28,5	31,0	14
43 A51 0828	8	1/4	25,0	28,5	32,0	17
43 A51 0838	8	3/8	28,0	30,0	36,0	19
43 A51 1028	10	1/4	25,0	32,5	32,0	17
43 A51 1038	10	3/8	28,0	32,5	36,0	19
43 A51 1428	14	1/4	38,0	36,5	44,0	17
43 A51 1438	14	3/8	38,5	36,5	46,0	22
43 A51 1448	14	1/2	40,0	36,5	49,0	24
43 A51 2268	22	3/4	55,0	46,0	64,0	32

### Single Banjo Body

O/D tube

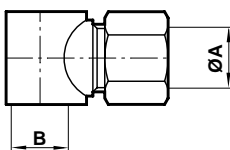

Product number	A O/D tube	B for BSPP Bolt	D	C	E A/F	F A/F	S
43 051 0418	4	1/8	30	17	13	10	3,0
43 051 0618	6	1/8	28	17	13	13	4,5
43 051 0628	6	1/4	36	17	18	13	4,5
43 051 0818	8	1/8	38	17	18	14	6,0
43 051 0828	8	1/4	38	17	18	14	6,0
43 051 0838	8	3/8	41	20	21	14	6,0
43 051 1028	10	1/4	43	20	21	19	8,0
43 051 1038	10	3/8	43	20	21	19	8,0
43 051 1428†	14	1/4	50	30	25	24	12,0
43 051 1438†	14	3/8	50	30	25	24	12,0
43 051 1448†	14	1/2	50	30	25	24	12,0
43 051 2268†	22	3/4	63	42	32	36	20,0

† to be used with bolts marked \* alongside

### Banjo Bolt

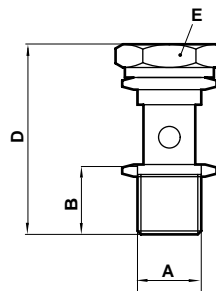

Product number	A Thread BSPP	B	D	E
43 A00 0018	1/8	10,0	31,0	14
43 A00 0028	1/4	12,0	32,0	17
43 A00 0038	3/8	13,5	36,0	19
43 A00 0L28*	1/4	14,5	44,0	17
43 A00 0L38*	3/8	14,5	46,0	22
43 A00 0L48*	1/2	18,0	49,0	24
43 A00 0L68*	3/4	20,0	64,0	32

\* to be used with bodies marked † alongside



## Compression Fittings

### 43 Series Metric External Nut

#### Universal Tubing Sleeve

Suitable for nylon and metallic tubing

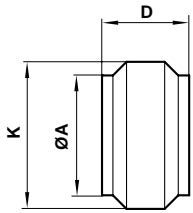

Product number	A O/D tube	D	K
43 002 0400	4	6,0	6,5
43 002 0600	6	6,5	8,5
43 002 0800	8	7,0	10,5
43 002 1000	10	8,0	13,5
43 002 1200	12	8,5	16,0
43 002 1400	14	8,5	18,0
43 002 1500	15	8,5	18,0
43 002 1600	16	9,0	20,0
43 002 1800	18	9,5	22,0
43 002 2200	22	10,0	28,0

Natural Brass Finish

#### Tubing Nut

For use with universal tubing sleeve only

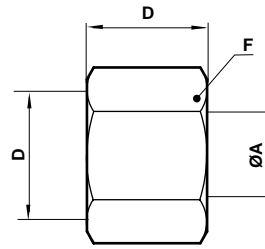

Product number	A O/D tube	B thread	D	F A/F
43 001 0400	4	M8x1,0	10,5	10
43 001 0600	6	M10x1,0	10,5	13
43 001 0800	8	M12x1,0	12,5	14
43 001 1000	10	M16x1,5	15,0	19
43 001 1200	12	M18x1,5	15,0	22
43 001 1400	14	M20x1,5	15,0	24
43 001 1500	15	M20x1,5	15,0	24
43 001 1600	16	M22x1,5	17,0	27
43 001 1800	18	M24x1,5	18,0	30
43 001 2200	22	M30x1,5	19,0	36

#### Conical Tubing Sleeve

Suitable for metallic tubing only

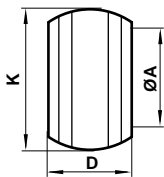

Product number	A O/D tube	D	K
43 003 0400	4	5,5	6,5
43 003 0600	6	6,5	8,5
43 003 0800	8	6,5	10,5
43 003 1000	10	7,5	13,5
43 003 1200	12	8,0	16,0
43 003 1400	14	8,5	18,0
43 003 1500	15	9,0	18,0
43 003 1600	16	9,5	20,0
43 003 1800	18	10,0	22,0
43 003 2200	22	11,0	28,0

Natural Brass Finish

#### Conical Tubing Nut

For use with conical tubing sleeve only

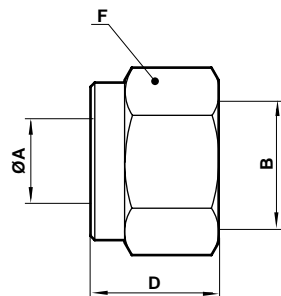

Product number	A O/D tube	B thread	D	F A/F
43 034 0400	4	M8x1,0	9,5	10
43 034 0600	6	M10x1,0	10,5	12
43 034 0800	8	M12x1,0	11,5	14
43 034 1000	10	M16x1,5	13,5	19
43 034 1200	12	M18x1,5	13,5	21
43 034 1400	14	M20x1,5	14,5	23
43 034 1500	15	M20x1,5	16,0	23
43 034 1600	16	M22x1,5	17,0	25
43 034 1800	18	M24x1,5	18,0	28
43 034 2200	22	M30x1,5	18,0	34

Note: This nut has an identification diameter on the outboard end



## Tube Support

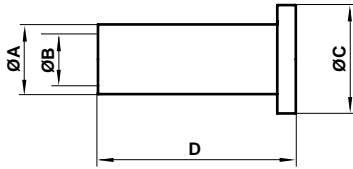

Product number	Tube	A	B	C	D
43 033 0403	4/2,7	2,7	1,5	3,8	13,5
43 033 0604	6/4,0	4,0	3,0	5,0	13,5
43 033 0806	8/6,0	6,0	5,0	7,0	16,5
43 033 1008	10/8,0	8,0	7,0	9,0	17,5
43 033 1209	12/9,0	9,0	8,0	11,0	19,5
43 033 1210	12/10,0	10,0	9,0	11,0	19,0
43 033 1412	14/12,0	12,0	11,0	13,5	21,5
43 033 1512	15/12,5	12,5	11,5	14,0	21,5
43 033 1613	16/13,0	13,0	12,0	15,0	22,5
43 033 1815	18/15,0	15,0	14,0	17,5	23,5
43 033 1816	18/16,0	16,0	15,0	17,5	23,5
43 033 2218	22/18,0	18,0	16,5	19,0	25,0

Natural Brass Finish

Note: For use on soft plastic tubing

## Warning

These products are intended for use in industrial compressed air systems only. Do not use these products where *pressures* and *temperatures* can exceed those listed under '**Technical Data**'. Before using these products with fluids other than those specified, for non-industrial applications, life-support systems, or other applications not within published specifications, consult Norgren.

Through misuse, age, or malfunction, components used in fluid power systems can fail in various modes. The system designer is warned to consider the failure modes of all component parts used in fluid power systems and to provide adequate safeguards to prevent personal injury or damage to equipment in the event of such failure.

**System designers must provide a warning to end users in the system instructional manual if protection against a failure mode cannot be adequately provided.**

System designers and end users are cautioned to review specific warnings found in instruction sheets packed and shipped with these products where applicable.