

**Instrument Regulator
Stainless Steel Model
1/4" PTF**

- **Metallic parts meet NACE† recommendations**
- **Lloyd's Register Type Approved**
- **Compact instrument units with high performance**
- **Stable regulation and temperature compensation**
- **Excellent flow and regulation characteristics**

† National Association of Corrosion Engineers - recognised oil-field recommendation for resistance to sulphide stress cracking common in well-head and other corrosive environments.

Technical Data

Fluid: Compressed air

Maximum pressure: 31 bar (450 psig)

Operating temperature: -40° to +80°C (-40° to +175°F) *

* Air supply must be dry enough to avoid ice formation at temperatures below +2°C (+35°F).

Typical flow at 7 bar (100 psig) inlet pressure, 1 bar (15 psig) set pressure and a droop of 0,05 bar (1 psig) from set:
8 dm³/s (17 scfm)

Typical relief differential at 2 bar (30 psig) outlet pressure:
0,16 bar (2.3 psig)

Maximum bleed flow at 2 bar (30 psig) outlet pressure (relieving types only):
1,5 cm³/s (0.003 scfm)

Gauge ports:
1/4" PTF

Relief ports:
1/8" PTF

Materials (standard option):

Body: Stainless steel

Bonnet: Stainless steel

Adjusting screw: Stainless steel

Elastomeric materials: Synthetic rubber

Ordering Information

See *Ordering Information* on the following pages.

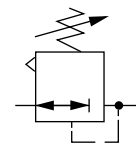
ISO Symbol

Relieving

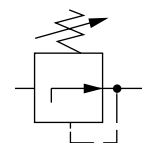

Non Relieving



Typical Performance Characteristics

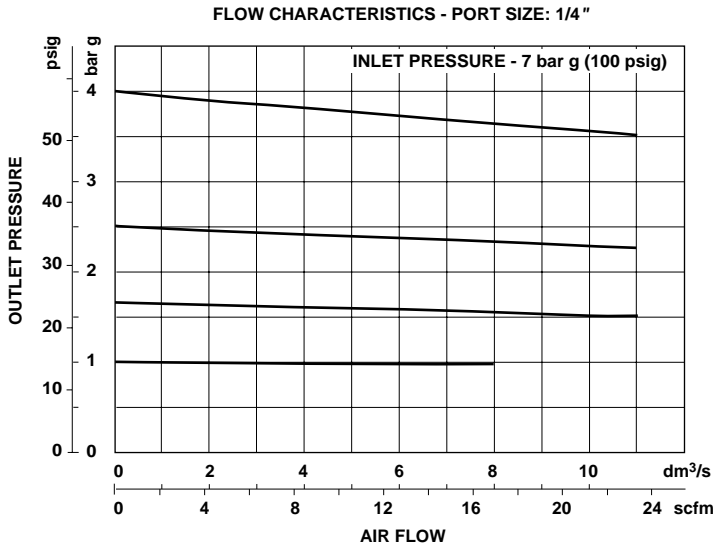

Ordering Information. Models listed are PTF threads, hex. screw adjustment, 0,04 to 2 bar (0.6 to 30 psig) outlet pressure adjustment range, and without gauge.

Port Size	Model Number	Relief Type	Weight kg (lbs)
1/4" PTF	R38-240-RNCA	Relieving	0,48 (1.06)
1/4" PTF	R38-240-NNCA	Non relieving	0,46 (1.01)

Alternative Models

R 3 8 - ★ ★ ★ - ★ ★ ★ ★

Port Size	Substitute
1/4" PTF	2
Type	Substitute
Stainless steel (standard)	4
Viton	5
Fluorosilicon	6
Mounting Option	Substitute
Without	0
With bracket and nut	1
With panel nut only	2
With handwheel and nut	3
With handwheel, bracket and nut	4
With handwheel only	5





Threads	Substitute
PTF	A
ISO Rc taper	B
ISO G parallel	D
API.LP.INT	K
Outlet Pressure Adjustment Ranges*	Substitute
0,04 to 2 bar (0.6 to 30 psig)	C
0,07 to 4 bar (1 to 60 psig)	F
0,25 to 7 bar (3.6 to 100 psig)	K
0,50 to 10 bar (7.2 to 150 psig)	M
Gauges	Substitute
Without	N
Diaphragm	Substitute
Relieving	R
Non relieving	N

* Outlet pressure can be adjusted to pressures in excess of, and less than, those specified. Do not use these units to control pressures outside of the specified ranges.

Please contact our technical service for details of non standard models including maximum pressure stop, etc.

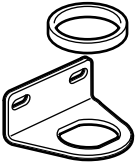

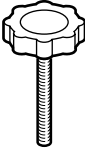
Accessories

 Wall Mounting Bracket Kit 18-001-973	 Panel Nut 5988-02	 Plastic Adjusting Knob 655-97	 Tamper Resistant Waterproof Cap 18-004-987 (Aluminium non-contact part)
--	---	---	--

 Ø 40 mm Pressure Gauge 1/4" PTF Connection	
25 bar g (350 psig)	18-013-905
10 bar g (120 psig)	18-013-909
6 bar g (80 psig):	18-013-913

Dimensions mm (inches)

Panel mounting hole diameter: 42 mm (1.65")

Panel thickness: 0 to 6 mm (0 to 0.24")

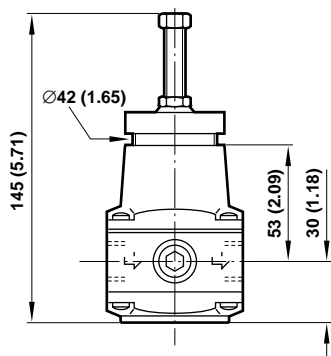
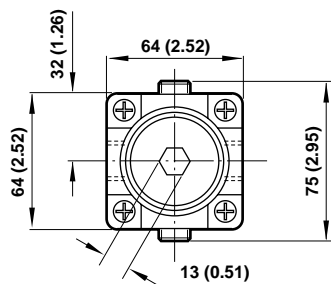



Bracket Mounting

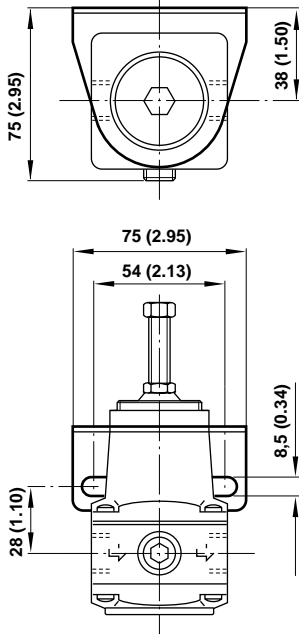

Bracket Kit Reference

Item	Part Number
All models	18-001-973

Includes panel mounting nut.

Service Kits (standard option)

Item	Type	Part number
2 bar	Relieving	R38-100-R
	Non relieving	R38-100-NR
4 bar, 7 bar	Relieving	R38-101-R
	Non relieving	R38-101-NR
10 bar	Relieving	R38-102-R
	Non relieving	R38-102-NR

Service kits includes diaphragm assembly, o-ring, valve, valve spring and 8 pan head screws.

Warning

These products are intended for use in industrial compressed air systems only. Do not use these products where pressures and temperatures can exceed those listed under 'Technical Data'.

Before using these products with fluids other than those specified, for non-industrial applications, life-support systems, or other applications not within published specifications, consult NORGREN.

Through misuse, age, or malfunction, components used in fluid power systems can fail in various modes. The system designer is warned to consider the failure modes of all component parts used in fluid power systems and to provide adequate safeguards to prevent personal injury or damage to equipment in the event of such failure.

System designers must provide a warning to end users in the system instructional manual if protection against a failure mode cannot be adequately provided.

System designers and end users are cautioned to review specific warnings found in instruction sheets packed and shipped with these products.

Water vapor will pass through these units and will condense into liquid if air temperature drops in the downstream system. Install an air dryer if water condensation could have a detrimental effect on the application.